

# ARCHITECTURAL RAILING SYSTEMS

Glass Railings/Balustrades | TAPER-LOC® Railing Systems  
Aluminum Railing Systems | Welded Railing Systems | Post Railing Systems  
Windscreens | Component and Accessory Items Complement Each Product Line  
New Products Designed and Engineered for Commercial and Residential Needs

**BLUMCRAFT**  
A DIVISION OF C.R. LAURENCE CO., INC.

**HANSEN**  
WORLD-CLASS ALUMINUM RAILING  
ARCHITECTURAL SYSTEMS  
A DIVISION OF C.R. LAURENCE CO., INC.

**ICC**  
**ES**™ ESR-3269  
ESR-3842

**C.R. LAURENCE COMPANY**

WORLDWIDE MANUFACTURER AND SUPPLIER

Glazing, Architectural, Railing, Construction, Industrial, and Automotive Supplies  
[crlaurence.com](http://crlaurence.com) | [usalum.com](http://usalum.com) | [crl-arch.com](http://crl-arch.com)

**CRL**  
**US ALUMINUM**  
A CRH COMPANY



# BUILDING GLASS RAILING SYSTEMS SAFER, STRONGER, WITH BRILLIANT TRANSPARENCY



ICC  
ES<sup>TM</sup> ESR-3269  
ESR-3842

Our award-winning **GRS Glass Railing System** has just received **ICC-ES<sup>®</sup>** approval. This means that this documented, certified, and proven railing system eliminates the cost and time delays often required for project specific engineering. We are proud to say that it's the first glass railing system to have ever received this approval.

This criteria covers the design and testing compliance with Section 2407 of the IBC and Section R312 of IRC.

## CRL GRS GLASS RAILING SYSTEMS AND COMPONENTS

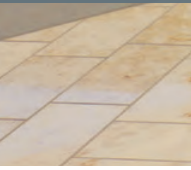

CRL's **GRS Glass Railing Systems** for interior and exterior applications are designed to provide an attractive 'all-glass' frameless look to view-oriented residential or commercial projects. Designed for monolithic or laminated glazing, this high quality system also serves as an effective wind barrier, further enhancing the outdoor environment. CRL offers a variety of Base Shoes, Cap Rails, Cladding, Corners, Brackets, and Accessories. Custom fabricated railings for project specific requirements are also available.





# TAPER-LOC® X

## DRY GLAZE RAILING SYSTEM



CRL TAPER-LOC®  
Installation/Removal Tool Kit

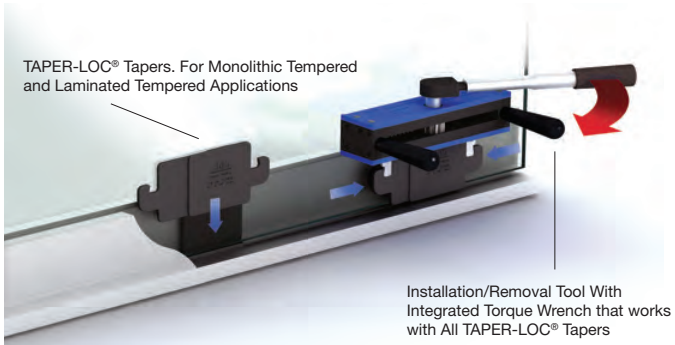

- Glass Railings Designed, Tested, and Engineered by CRL for Commercial or Residential Applications
- Reduces Installation Time By 50%
- Supports 1/2" (12 mm), 19/32" (15 mm) and 3/4" (19 mm) Monolithic Tempered Glass
- Also Designed for Laminated Glazing Applications 9/16" (13.52 mm), 11/16" (17.52 mm), 27/32" (21.52 mm), 1-1/16" (25.52 mm)

The installation process just got easier with CRL's patented Horizontal TAPER-LOC® dry glazed design. Designed for both commercial and residential applications, this is just the system architectural railing installers have been waiting for. This new system will reduce your installation time by more than 50%, and has been tested and engineered to meet the strictest building code requirements.

U.S. Patents 8,122,654 and 8, 201,366/Commonwealth of Australia Patent No. 200820752

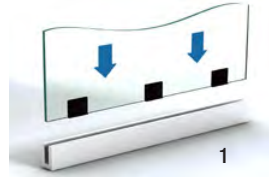

Adhere TAPER-LOC® L-Setting Blocks to the bottom edge of glass.

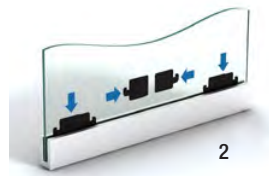

Install TAPER-LOC® Tapers with CRL's TLK12 Installation/Removal Tool to lock the glass securely in place.

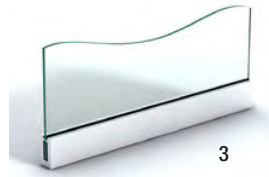

Roll in the top glazing vinyl and you're done



CRL PAL Plumb/Angle/  
Level Locator Kit



**NEW!** Adjustable Taper Set

## CRL TAPER-LOC® SAFETY SEALS FOR MONOLITHIC AND LAMINATED TEMPERED GLASS BASE SHOE

- Helps Prevent Unsafe Leaning Over Railing During Installs
- "Drop-Side" Seal Installs in Base Shoe Prior to Glass

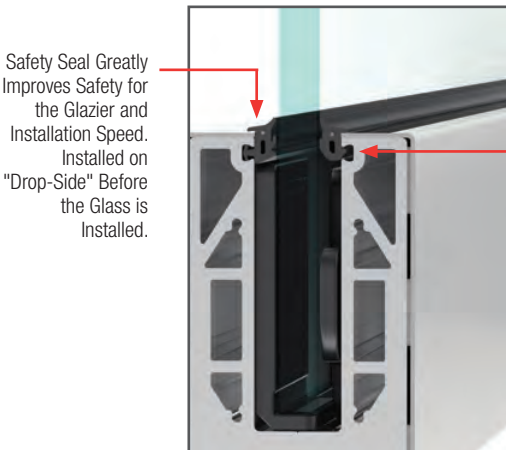





1



2



3

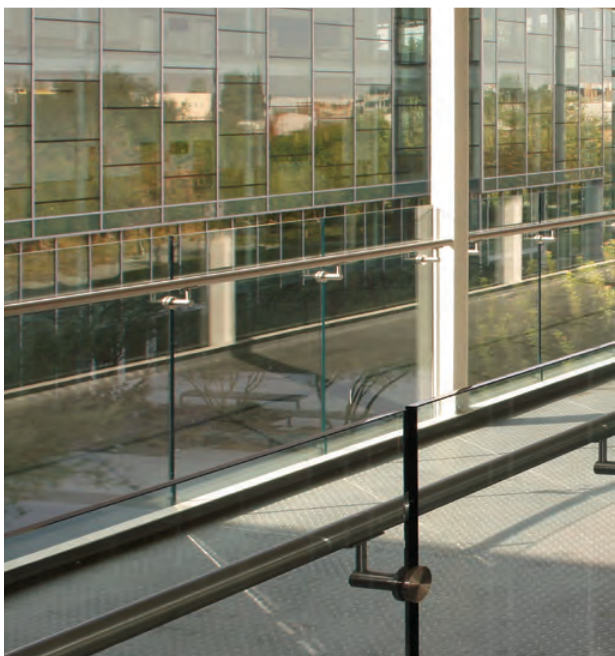

1) GRS Radiused Stainless Steel Glass Railing System with Cap Rails  
2) GRS Stainless Steel Glass Railing System with Cap Rails and HRS Hand Rails



4

3) GRS Radiused Stainless Steel Glass Railing System with Custom Low Profile and HRS Hand Rails  
4) SRS Stainless Steel Standoff Railing System with HRS Hand Rails



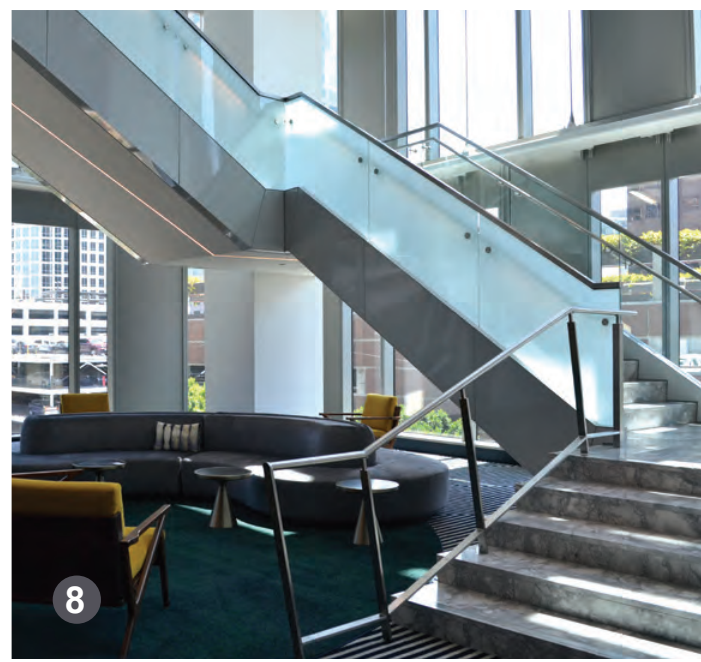

**5)** GRS Radiused Glass Railing System Balconies with Cap Rails  
**6)** GRS Stainless Steel Base Shoe combined with SRS Standoff Railing System with Cap Rails and HRS Hand Rails

**7)** GRS Glass Railing System Bridge with Cap Rails  
**8)** GRS Stainless Steel Glass Railing System with HRS Hand Rails and Custom-Fabricated Stainless Steel Post System





## CRL P-SERIES STAINLESS STEEL POST RAILING SYSTEM

CRL manufactures a comprehensive selection of **Post Railing Kits** that combine the durability of stainless steel components with innovative designs and engineering. Designed for interior or exterior hand rail and guard rail applications, these low maintenance stainless steel posts come ready to install. We make selecting post railing systems easy with our **Quick Pick P1 and P7 Post Kits**. All you have to do is choose the post style, glass fitting type, and mounting method and you're done. We offer both fixed and swivel saddles.

**QUICK PICK**  
RED-E Ship

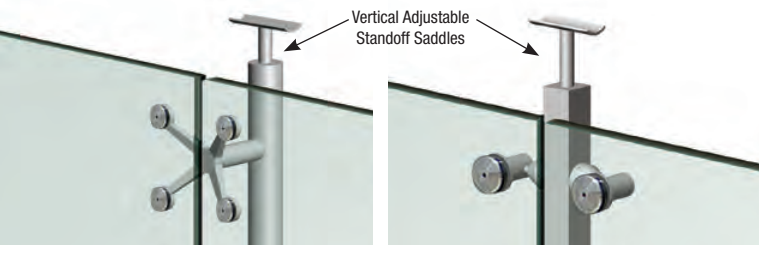
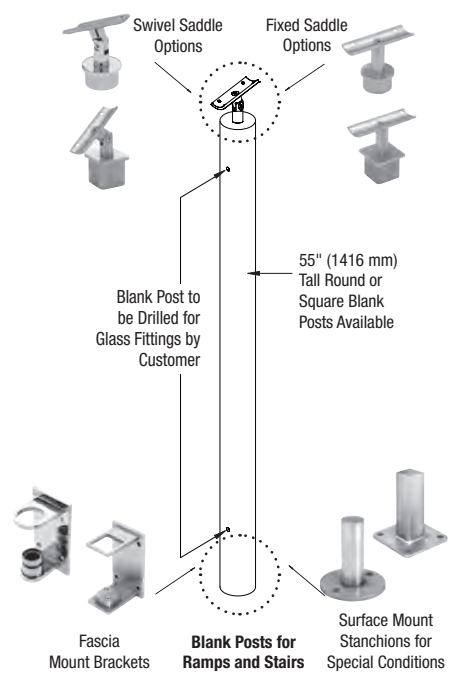
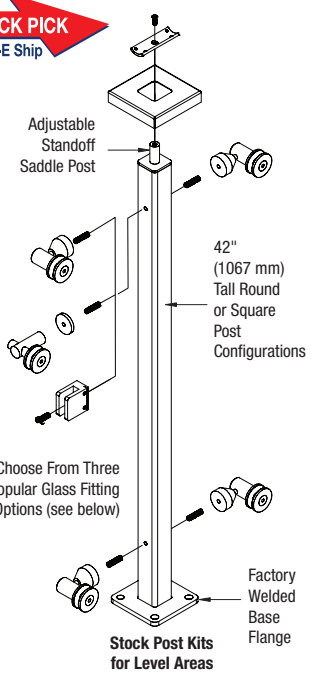
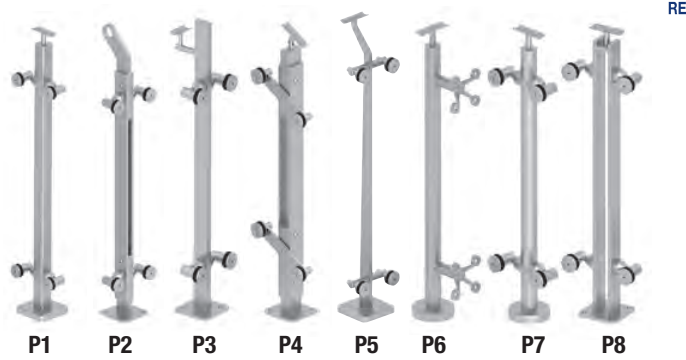





JEAN AND DAVID FLEMING  
GRAND STAIRCASE

## CRL SRS STANDOFF GLASS RAILING SYSTEM

CRL manufactures **Standoff Railing Systems**. By specializing in the design and manufacturing of this innovative system, we offer you the ability to create custom railings that will address project-specific criteria. Rest assured that the products we offer represent the current evolution of the railing industry because product development is an ongoing process at CRL.

**NEW! Square Profile** is now available to give you more design flexibility. Square Caps provide a distinct geometric accent that's ideal for contemporary applications.



**NEW!**  
SQUARE PROFILE







## ARS ALUMINUM RAILING SYSTEMS

**Hansen Architectural Systems**—part of the CRL family of brands—has over 20 years of experience specializing in the design, fabrication, and installation of aluminum railing systems. It's a name trusted by the industry, and we're proud to offer their full line of quality systems.

You can select from several high-performance systems for most any application. They include Glass Guardrails, Glass Windscreens, Cable Railing Systems, and traditional Picket Railing Systems. There are eight top rail styles to choose from, as well as eight standard finishes (custom finishes available).

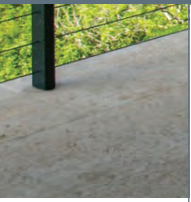





## TECHWALL /AWS ALUMINUM WINDSCREEN SYSTEM

Our **Aluminum Windscreen System** is developed to provide an attractive, maintenance-free glass wall that's perfect for residential or commercial projects. The system incorporates large glass panels with subtle aluminum framing to preserve views while creating a functional barrier against air currents. Round and rectangular profiles are available.

All Aluminum Windscreen Systems can be used in conjunction with a concrete slab, block wall, or individual footings. If our stock components don't fit your specification, allow us to design a system that can. CRL has the ability to design, engineer, and fabricate custom systems that will not only meet your needs for safety and security, but also your aesthetic preferences.







## CRL GLASS WINDSCREEN AND POOL SURROUNDS

CRL's **Frameless Glass Windscreen Base Shoe System** and **Frameless Windscreen Brackets** are designed to provide an attractive, maintenance-free glass wall that will enhance any residential or commercial application. This system offers virtually unobstructed views for glass windscreen or fencing requirements. (Not designed for guard rail applications). CRL's **Frameless Windscreen Systems** are innovative glass wall systems that provide an almost invisible "frameless" look without vertical posts used between the panels of glass. They are solely supported from the bottom by aluminum base shoes or high strength stainless steel clamps.

Our **NEW Point Supported Mini Posts** can be used in a variety of windscreen applications. Their frameless design provides unobstructed views and attractive, all-glass aesthetics.





## CRL GRS GLASS GATE SYSTEMS

- Cap Railing Swinging Gate Systems
- Models With Glass Ready to Install
- Self Closing Systems Available

CRL offers an array of Gate Systems and hardware to help protect areas such as interior office spaces, pool surrounds, decks, patios, and outdoor dining areas. Accompanying security options and closing devices can be incorporated into the design as well. Systems are available for mounting to glass, walls, or posts, in a choice of several configurations.



## CRL GLASS GATE HARDWARE

- Dry Glaze Top / Bottom Patch Gate Rails
- Stainless Steel Post Kits
- Gate Hinges • Locks and Latches
- Gate Hardware Pivots, Fittings, and Closers

Top and Bottom Patch Gate Rails are available in polished and brushed stainless finishes, with matching sidelite rails available. Rails are supplied with our standard Kwik-Adjust® Pivot Alignment System. Closer Arms and Floor or Overhead Pivots are ordered separately. Stainless Steel Post Kits for Gates are designed for use with hinges or patch hardware. An assortment of Pivots, Fittings, Closers, Latches, and Hinges provide options for various gate designs.



## CRL ARS AND AWS GATE SYSTEMS

- Aluminum Railing Gate System
- Aluminum Windscreen Custom Gate System
- Fully Framed Architectural Gate System
- Premium Formed Stainless Steel Gate System

Let CRL Railing Technical Sales assist you in designing a gate system based on either our ARS (Aluminum Railing System) or AWS (Aluminum Windscreen System). The two systems offer distinctly different styles to choose from. The innovative Platinum Series Fully Framed Architectural Gate System is yet another choice. These gates are completely designed, engineered, and manufactured by CRL. Finally, please take a moment to review our Premium Formed Stainless Steel Gate System. It is ideal for high end pool fencing or barrier applications. Gate hinge and lock options provide flexibility of design.



## CRL ARS AND AWS GATE HARDWARE

- Hinges and Latches
- Hydraulic Gate Hinge-Closers
- Jackson® Panic Exit Devices
- Electric Strikes and Housings

Hinges, Latches, Hydraulic Gate Hinge-Closers, and Security Locks are just some of the hardware items used to complete our ARS (Aluminum Railing System) and AWS (Aluminum Windscreen System) Gates. Popular names such as Tru-Close®, Adams Rite®, Jackson®, and Lokk-Latch® bring name recognition to many of the component hardware items.







## CRL MONOLITHIC TEMPERED GLASS RAILING PANELS

Available Thickness:  
1/2" (12 mm), 5/8" (15 mm), and 3/4" (19 mm) "Rail Glass"

- Clear Tempered and Low Iron Starphire® Glass Types Available for Use With CRL's GRS Glass Railing Systems
- Flat Polished Vertical Edges, Horizontal Seamed Edges Standard
- 48" and 60" (1219 and 1524 mm) Wide Glass Panels in Stock
- Custom Sizes, Fabrication, and Edge Work is Also Available
- Works With CRL's Patented Dry Glazed TAPER-LOC® System
- Designed for Use With CRL's Monolithic Base Shoes
- Also Designed for Use With CRL's New 30% Lighter 8B Series Base Shoe

Designed for interior and exterior glass balustrade applications, CRL's "Rail Glass" is fabricated and tempered in accordance with ANSI Z97.1, and CPSC 16 CFR1201. All "Rail Glass" is available in two stock sizes. Custom sizes, fabrication, and edge work is also available upon request.

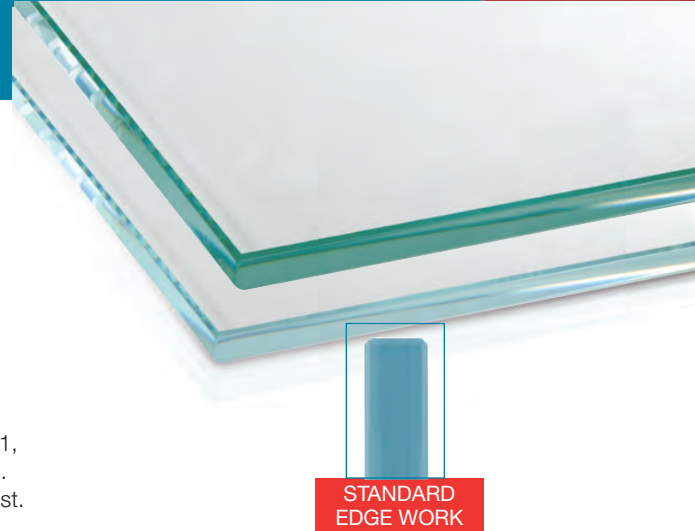

STANDARD  
EDGE WORK

## CRL LAMINATED TEMPERED GLASS RAILING PANELS

Available Thickness:  
9/16" (13.52 mm), 11/16" (17.52 mm), 27/32"  
(21.52 mm), and 1-1/16" (25.52 mm) "Rail Glass"

- Laminated Clear Tempered and Low Iron Starphire® Glass Types Available for Use With CRL's GRS Laminated Glass Railing Systems
- Flat Polished Vertical Edges With CRL's "Precise Edge" Technology
- 48" and 60" (1219 and 1524 mm) Wide Glass Panels in Stock
- Custom Sizes, Fabrication, and Edge Work is Also Available
- Works With CRL's Patented Dry Glazed TAPER-LOC® System
- Also Designed for Use With CRL's New 30% Lighter 9BL Series Base Shoe
- Meets IBC 2015 Building Code Requirements

CRL's Laminated "Rail Glass" panels for glass balustrade applications meet the test criteria of ASTM C1172, ANSI Z97.1, and CPSC 16, and CFR1201 standards, and are produced with a rigid Ionoplast interlayer. Our "Precise Edge" Technology dramatically improves the edge quality of laminated glass and gives each flat polished edge a consistent clean look and feel. All Laminated "Rail Glass" is available in two stock sizes. Custom sizes, fabrication, and edge work is also available upon request.



PRECISE EDGE  
TECHNOLOGY





## HRS HAND RAILING SYSTEM

CRL's **HRS Hand Rails** is designed for stairways, ramps or anywhere that requires the need for A.D.A. compliant assist rails. CRL offers a wide range of component parts for almost every application. Offered in five standard architectural finishes for wall mount, post mount, and glass mount applications. Custom fabrication and finishing is also available.

Take advantage of our optional **NEW LED Lighting System** for **HRS Hand Rails** to improve visibility and safety, while creating dramatic visuals that can't be ignored.

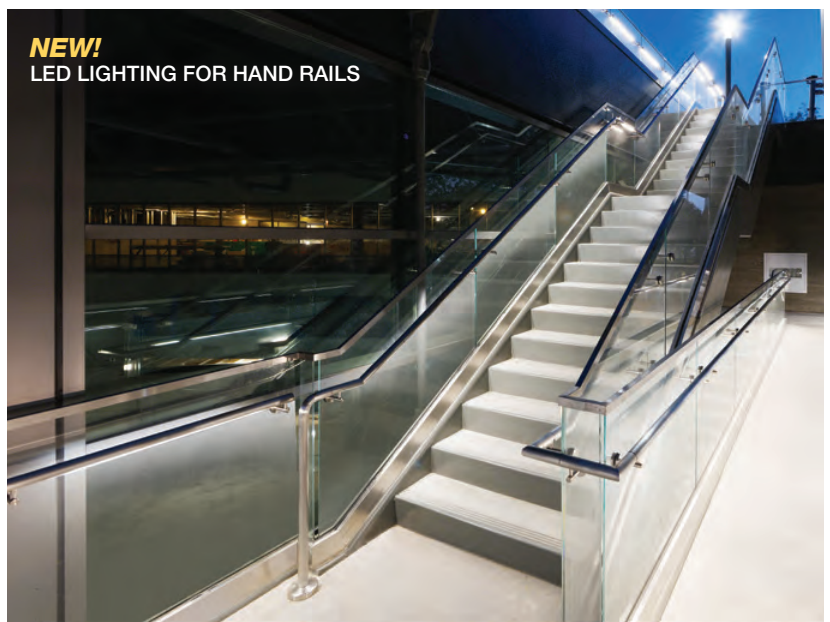
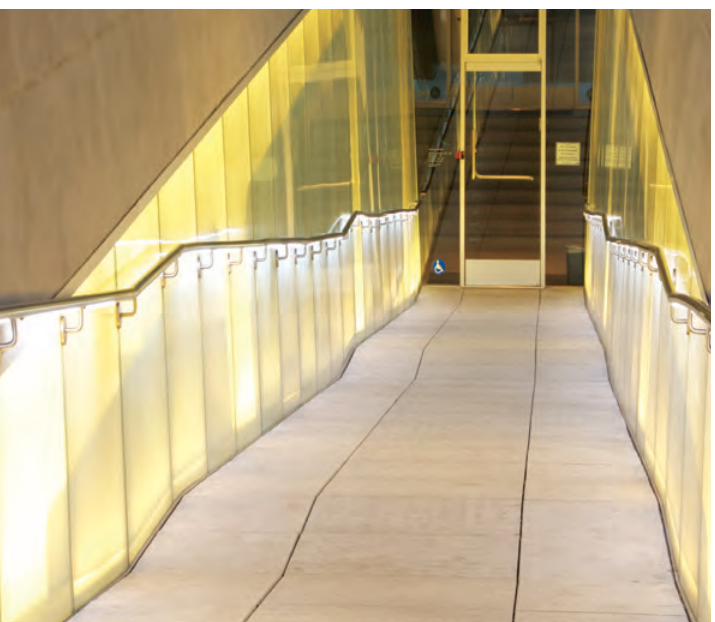





- Produces a Complete Quote Package Instantly
- Accessed from Your Computer, Phone or Tablet.
- Produces a Full Color 3D Rendering and Dimensioned Plan View for Field Installation
- Generates Quotes/Orders in Minutes
- Allows You to Order Material Directly From Your Computer
- Determines All Material Quantities Needed for Each Project
- Produces All Glass Sizes Needed for Your Railing or Windscreen Job

# HAND RAILS ONLINE®



**PRODUCES A COMPLETE QUOTE PACKAGE INSTANTLY**  
 Glass Magazine Crystal Achievement Award Winner:  
*"Most Innovative Industry-Specific Software"*

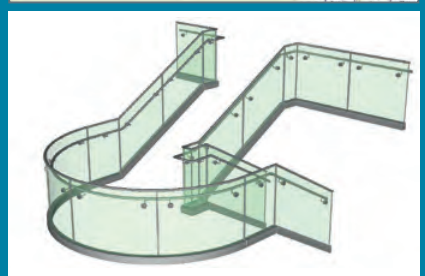

TRY OUR  
**30 DAY FREE TRIAL**  
[crlaurence.com/hrol](http://crlaurence.com/hrol)





## CUSTOM APPLICATIONS

*CityCenter Las Vegas: project included Custom Fabricated Stainless Steel LED Lighted Railing and Hand Rail Systems, as well as Custom Glass Wall Systems and Architectural Metals.*

CRL has the ability to engineer and fabricate virtually any architectural design. Our state-of-the-art manufacturing facilities offer rapid customization capabilities so you can get the glazing systems you need to meet the spec and schedule. CRL can customize an array of products for projects of all scopes, from high-rise residential to mixed-use developments. Rest assured knowing that our systems have been rigorously tested to meet the latest industry standards for quality and performance.



*Custom Fabricated Stainless Steel LED Lighted Railing and Hand Rail System*



*Custom P3 Series Post System with Cane Rail*







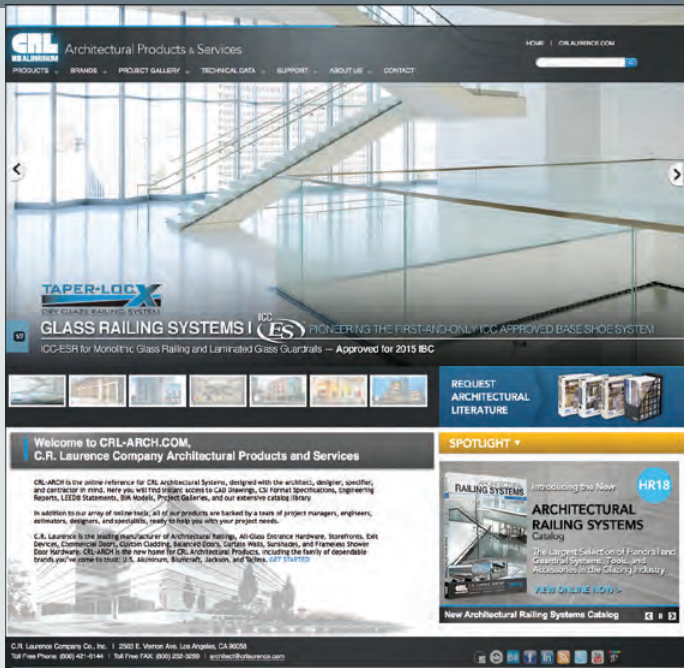





*Custom Fabricated Stainless Steel Post Glass Windscreen System*





## YOUR ONLINE ARCHITECTURAL RESOURCE

-  [SPEC / DATA](#)
-  [CAD/PDF DETAILS](#)
-  [BIM OBJECTS](#)
-  [LEED® STATEMENT](#)
-  [VIEW CATALOG](#)
-  [RELATED PRODUCTS](#)
-  [INFO REQUEST](#)
-  [RESOURCES](#)
-  [DESIGN MANUAL](#)
-  [PROJECT GALLERY](#)

**CRL-ARCH.com** is your portal to C.R. Laurence Company Architectural Products and Services. CRL-ARCH.com is the online reference for CRL architectural systems including U.S. Aluminum, Blumcraft, and Jackson. CRL-ARCH.com is a valuable reference tool designed with the architect, engineer, and specifier in mind. Here you will find easy access to CAD drawings, BIM objects, CSI format specifications, engineering reports, LEED® statements, project galleries, and our extensive library of catalogs.

## CRL Master and Specialty Catalogs



- 03 SEALANTS, ADHESIVES, AND FASTENERS
- 23 FRAMELESS SHOWER DOOR HARDWARE
- 43 AUTO GLASS TOOLS AND WINDOWS
- 53R GLASS AND GLAZING HARDWARE
- 63A ARCHITECTURAL HARDWARE
- 63R ARCHITECTURAL RAILING
- 73 TOOLS, MACHINERY, AND EQUIPMENT
- 83 DOOR AND WINDOW REPLACEMENT HARDWARE

									
<b>HR18</b> ARCHITECTURAL RAILING SYSTEMS	<b>AH18</b> ARCHITECTURAL HARDWARE	<b>SD19</b> FRAMELESS SHOWER DOOR HARDWARE AND SUPPLIES	<b>FS19</b> FRAMELESS SLIDING SHOWER DOOR SYSTEMS	<b>TH18</b> TRANSACTION AND SECURITY HARDWARE	<b>HS12</b> HOSPITALITY AND SERVICE HARDWARE	<b>CRL14D</b> DOORS AND ENTRANCE SYSTEMS	<b>DC14</b> DOOR CONTROLS HARDWARE AND ACCESSORIES	<b>SC14</b> SUN CONTROL SYSTEMS	<b>SCR14</b> SECURITY DOORS; DOOR & WINDOW SCREEN SYSTEMS

## C.R. LAURENCE World Wide

 **C.R. LAURENCE CO., INC.** [crlaurence.com](http://crlaurence.com)  
**Corporate Headquarters**  
**CRL UNITED STATES | [crlaurence.com](http://crlaurence.com)**  
 2503 E. Vernon Ave., Los Angeles, California 90058-1897  
 Toll Free Phone: (800) 421-6144 • Toll Free Fax: (800) 262-3299  
 International Phone: (323) 588-1281 • International Fax: (323) 581-6522

 **C.R. LAURENCE CANADA** [crlaurence.ca](http://crlaurence.ca)  
**Canadian Headquarters**  
**CRL CANADA | [crlaurence.ca](http://crlaurence.ca)**  
 65 Tigi Court, Concord, Ontario L4K 5E4  
 Toll Free Phone: (800) 421-6144 • Toll Free Fax: (800) 262-3299  
 International Phone: (905) 303-7966 • International Fax: (905) 303-7965

 **C.R. Laurence of Europe Ltd.** [crlaurence.co.uk](http://crlaurence.co.uk)  
**European Headquarters**  
**CRL UK | [crlaurence.co.uk](http://crlaurence.co.uk)**  
 Charles Babbage Ave., Kingsway Business Park, Rochdale, OL16 4NW England  
 Freephone: 00 800 0421 6144 • Freefax: 00 800 0262 3299  
 International Phone: +44 (0) 1706 863 600 • International Fax: +44 (0) 1706 869 860

 **C.R. Laurence of Europe GMBH** [crlaurence.de](http://crlaurence.de)  
**Stuttgart Area, Germany**  
**CRL GMBH | [crlaurence.de](http://crlaurence.de) | [crlaurence.eu](http://crlaurence.eu)**  
 Boschstrasse 7, D-74360, Ilfeld, Germany  
 Freephone: 00 800 0421 6144 • Freefax: 00 800 0262 3299  
 International Phone: +49 (0)7062 915 93 15 • International Fax: +49 (0)7062 915 93 16

 **C.R. LAURENCE AUSTRALIA** [crlaurence.com.au](http://crlaurence.com.au)  
**Australian Headquarters**  
**CRL Australia | [crlaurence.com.au](http://crlaurence.com.au)**  
 9 Shale Place, Eastern Creek, NSW 2766  
 Toll Free Phone: 1800 424 275 • Toll Free Fax: 1800 813 013  
 International Phone: +61 (2) 9851-3444 • International Fax: +61 (2) 9851-3445